

Performance

Lifting height — on tyres	5800.0 mm
Rated capacity	2600 kg
Max. reach on tyres	3100.0 mm

Weights

Weight (unladen)	5075 kg
------------------	---------

Traction

Standard tyres	SOLIDEAL 405/70-20 14PR
1st gear / low range (40 km/h option)	10 (10) km/h
1st gear / high range (40 km/h option)	31 (40 with 24 inch tyres) km/h

Drive System

Transmission	Hydrostatic with electronic regulation
Main drive	Hydrostatic motor

Engine

Make / Model	Bobcat D34
Fuel	Diesel
Cooling	Coolant
Rated power (ISO 14396:2002) at 2400 RPM	100.0 HP
Rated power (ISO 14396:2002) at 2400 RPM	74.5 kW
Maximum torque at 1400 RPM	430.0 Nm
Number of cylinders	4
Displacement	3.40 L

*Stage IIIB Bobcat D34 also available in 55kW/75HP version (without SCR/Ad-Blue after-treatment)

Hydraulic System

Pump type	Gear pump with LS valve
Pump capacity	100.00 L/min
Relief valve pressure setting	250.00 bar

Cycle Times

Lift time - no load	5.3 s
Lower time - no load	4.0 s
Telescope in time at max. reach - no load	3.6 s
Telescope in time at max. height - no load	3.6 s
Telescope out time at max. reach - no load	5.5 s
Telescope out time at max. height - no load	5.5 s

Brakes

Engine braking	Hydrostatic
Parking and emergency brake	Passive brake

Fluid Capacities

Fuel tank	115.00 L
Hydraulic reservoir	47.00 L

Environmental

Operator noise level (LpA) (EN 12053)	77 dB(A)
Operator noise level (LpA) (EN 12053) uncertainty	4 dB(A)
Level of acoustic power (LWA)	106 dB(A)
Whole body vibration (EN 13059)	1.70 ms ⁻²

Load Charts

With forks and standard 405/70x20 tyres

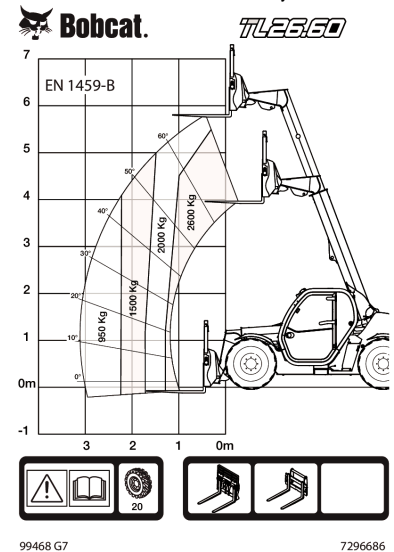

Dimensions

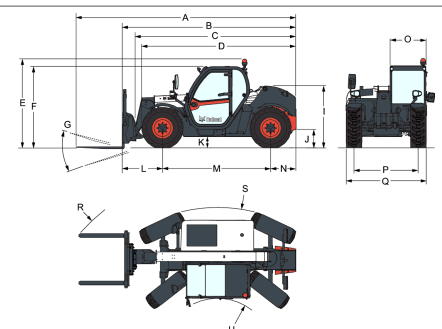

(-) 857.0 mm	(L) 1020.0 mm
(A) 5712.0 mm	(M) 2820.0 mm
(B) 4507.0 mm	(N) 667.0 mm
(C) 4140.0 mm	(O) 930.0 mm
(D) 4035.0 mm	(P) 1666.0 mm
(E) 2290.0 mm	(Q) 2100.0 mm
(F) 2156.0 mm	(R) 4713.0 mm
(G) 136.0°	(S) 4812.0 mm
(I) 1587.0 mm	(T) 3717.0 mm
(J) 264.0 mm	(U) 1329.0 mm